

SIDE Up to 60sqm inflow  
Up to 2.5l/s outflow

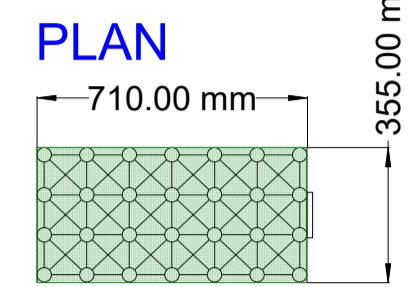
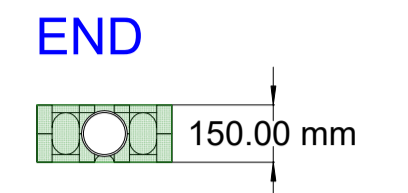

PVOD  
Ø110

PVOD05001  
Diffuser Unit  
710mm x 355mm x 150mm  
110mm Ø Socket

SIDE Up to 60sqm inflow  
Up to 2.5l/s outflow

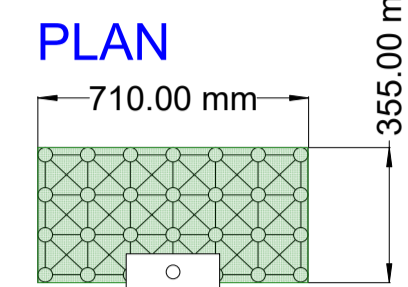
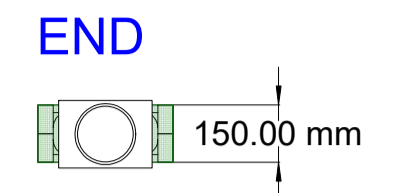

PVOD  
Ø160

PVOD05002  
Diffuser Unit  
710mm x 355mm x 150mm  
160mm Ø Spigot

SIDE Up to 162sqm inflow  
Up to 4.8l/s outflow

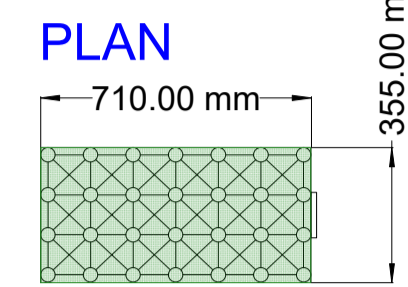
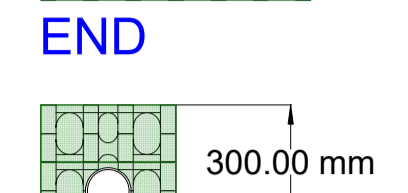

PVOD  
Ø110

PVOD05010  
Diffuser Unit  
710mm x 355mm x 300mm  
110mm Ø Socket

SIDE Up to 162sqm inflow  
Up to 4.8l/s outflow

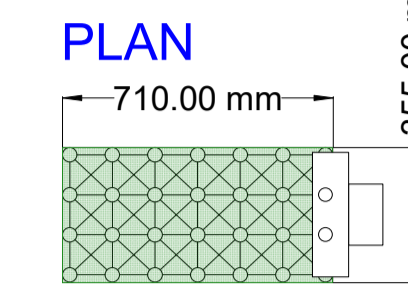
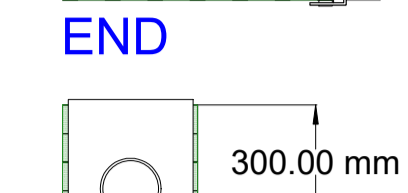

PVOD  
Ø160

PVOD05011  
Diffuser Unit  
710mm x 355mm x 300mm  
160mm Ø Spigot

SIDE Up to 162sqm inflow  
Up to 4.8l/s outflow

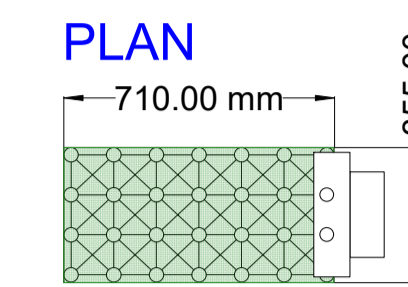
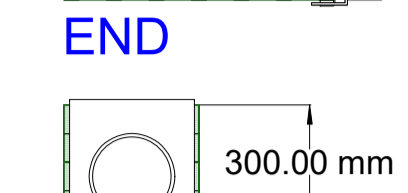

PVOD  
Ø225

PVOD05012  
Diffuser Unit  
710mm x 355mm x 300mm  
225mm Ø Spigot

SIDE Up to 108sqm inflow  
Up to 3.2l/s outflow

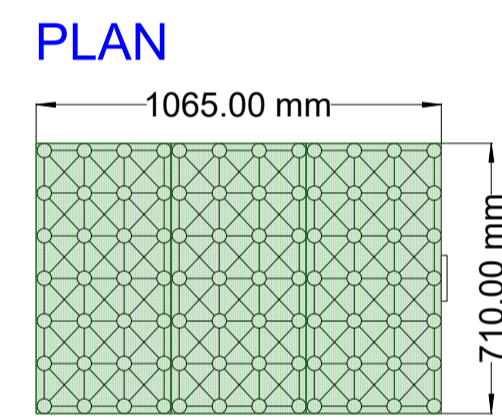
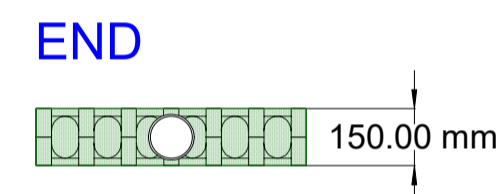
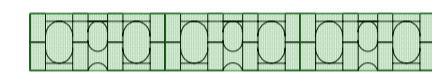

PVOD  
Ø110

PVOD05120  
Diffuser Unit  
1065mm x 710mm x 150mm  
110mm Ø Socket

SIDE Up to 108sqm inflow  
Up to 3.2l/s outflow

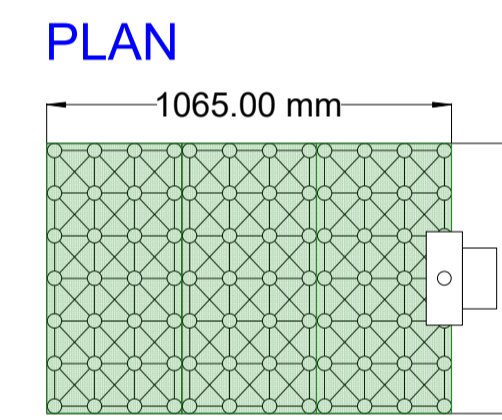
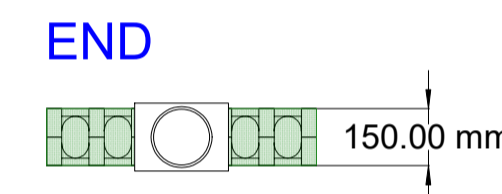

PVOD  
Ø160

PVOD05121  
Diffuser Unit  
1065mm x 710mm x 150mm  
160mm Ø Spigot

SIDE Up to 118sqm inflow  
Up to 3.5l/s outflow

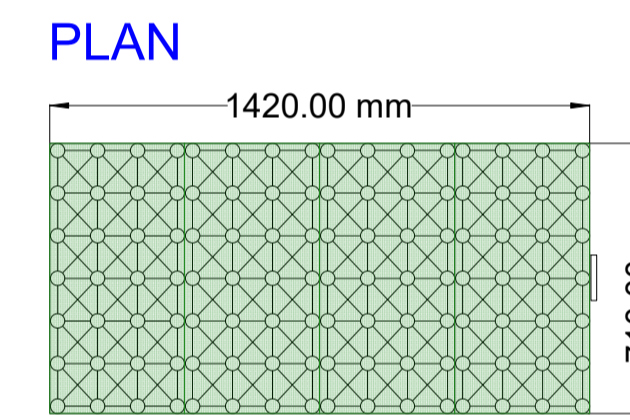
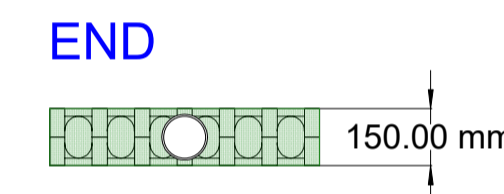

PVOD  
Ø110

PVOD05130  
Diffuser Unit  
1420mm x 710mm x 150mm  
110mm Ø Socket

SIDE Up to 118sqm inflow  
Up to 3.5l/s outflow

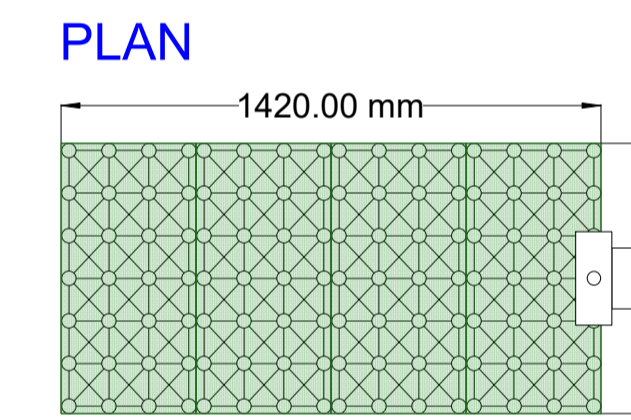
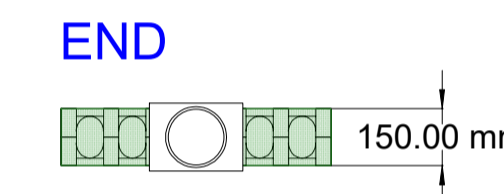
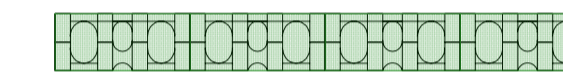

PVOD  
Ø160

PVOD05131  
Diffuser Unit  
1420mm x 710mm x 150mm  
160mm Ø Socket

SIDE Up to 189sqm inflow  
Up to 5.6l/s outflow

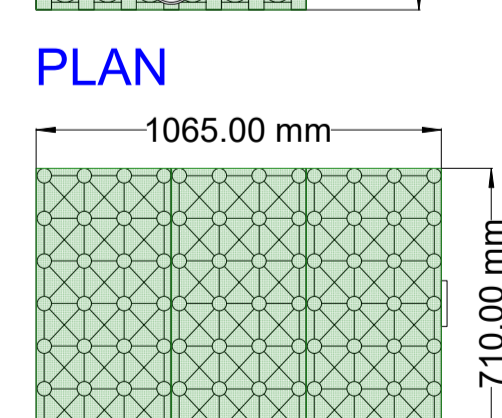
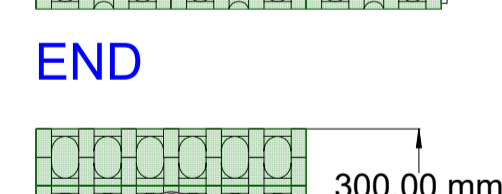

PVOD  
Ø110

PVOD05140  
Diffuser Unit  
1065mm x 710mm x 300mm  
110mm Ø Socket

SIDE Up to 189sqm inflow  
Up to 5.6l/s outflow

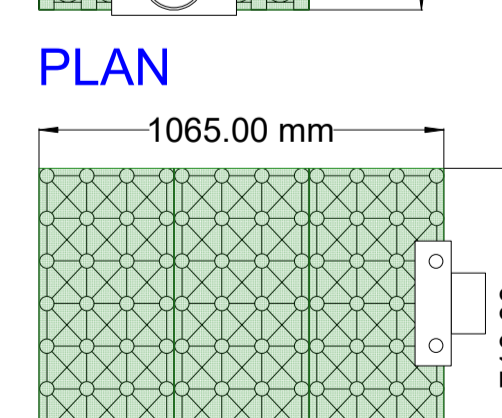
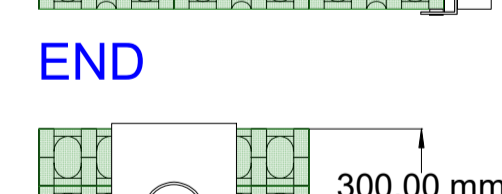

PVOD  
Ø160

PVOD05141  
Diffuser Unit  
1065mm x 710mm x 300mm  
160mm Ø Socket

SIDE Up to 125sqm inflow  
Up to 3.7l/s outflow

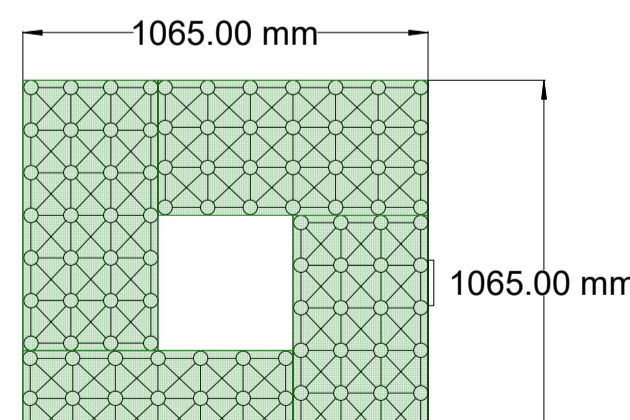
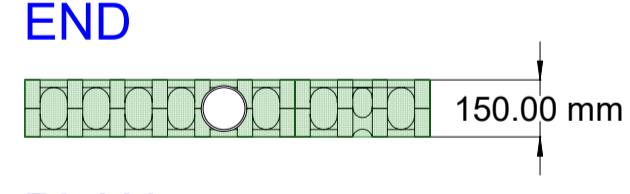

PVOD  
Ø110

PVOD05150  
Diffuser Unit  
1065mm x 1065mm x 150mm  
110mm Ø Socket

SIDE Up to 125sqm inflow  
Up to 3.7l/s outflow

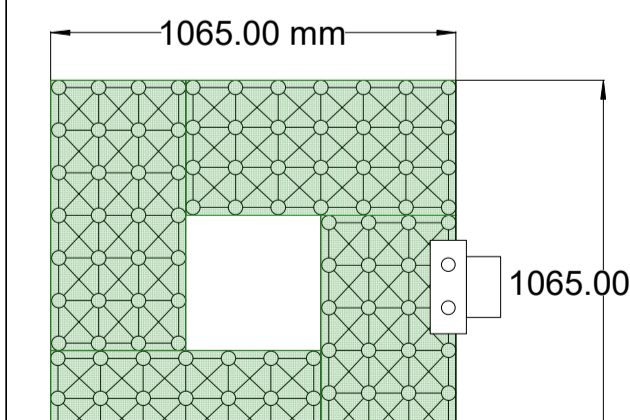
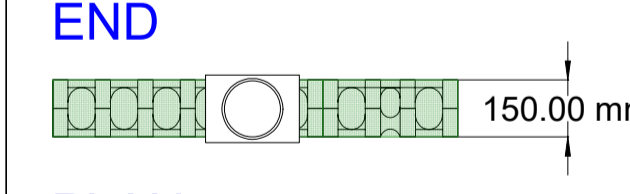

PVOD  
Ø110

PVOD05151  
Diffuser Unit  
1065mm x 1065mm x 150mm  
160mm Ø Socket

## Bespoke Diffuser Units

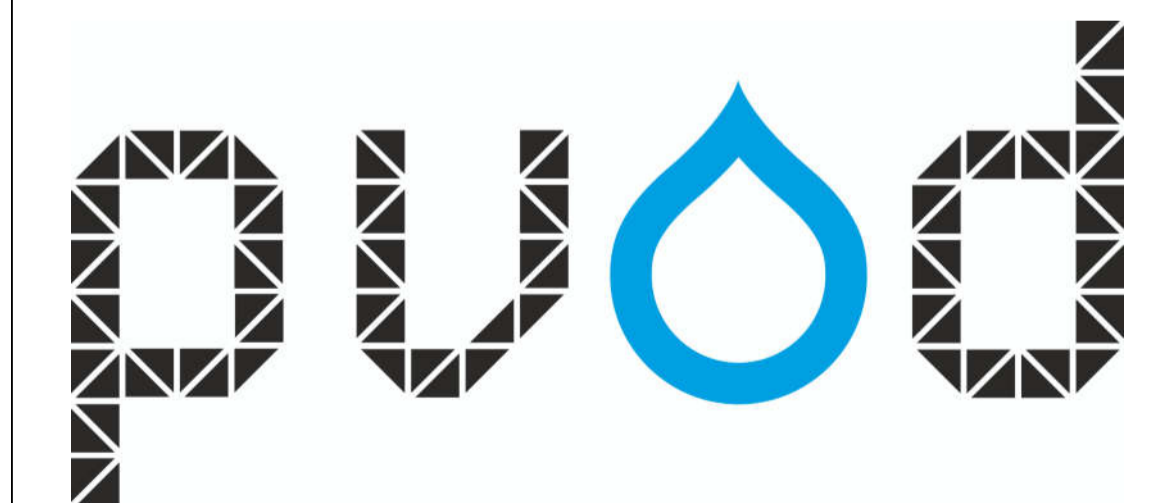

the Foundation for our Future



**Sel Environmental Ltd**  
Innovation Materialised

Canal House, Bonsall Street, Blackburn, BB2 4DD  
T: 01254 589987 Sales@selenvironmental.com